

# TrafoX

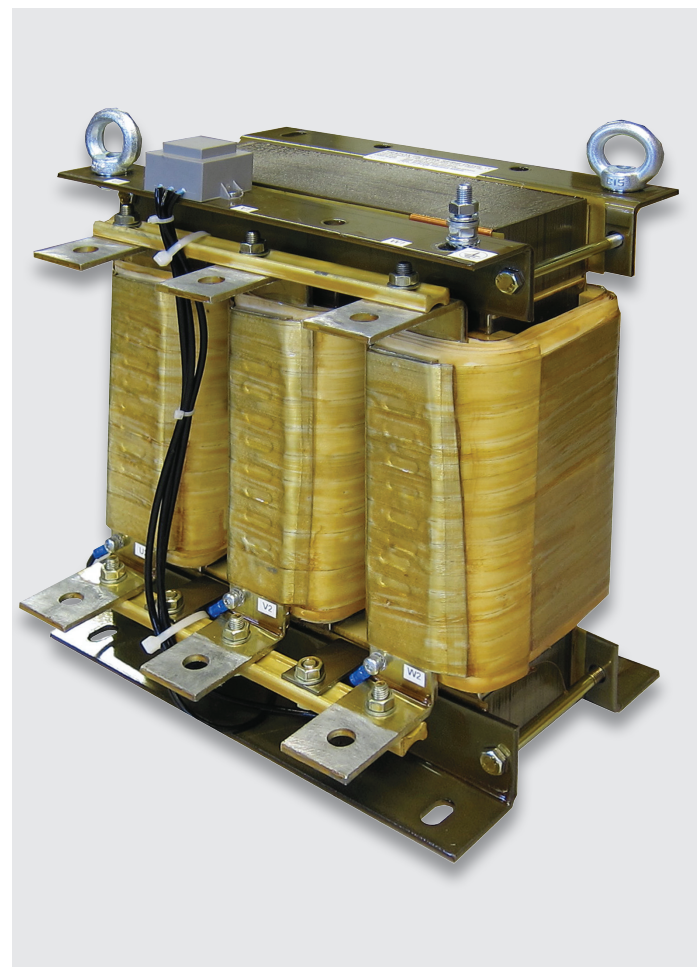
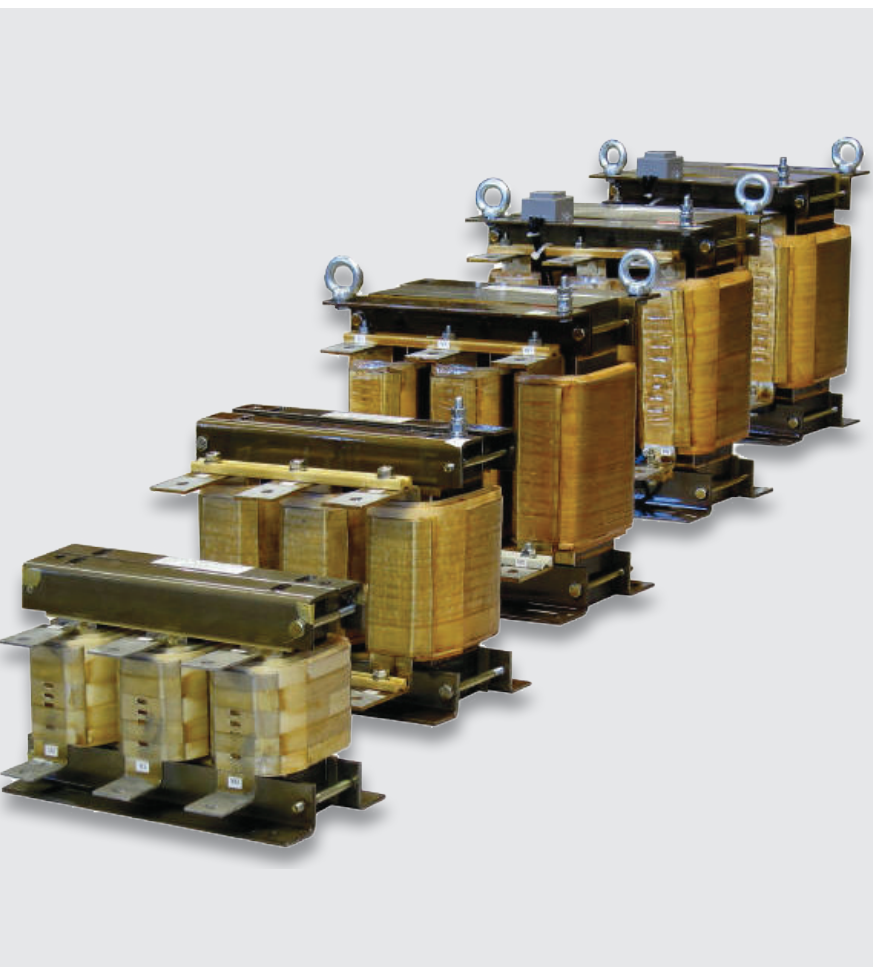

DU/dt  
Filters

# DU/dt Filters

FILTERS

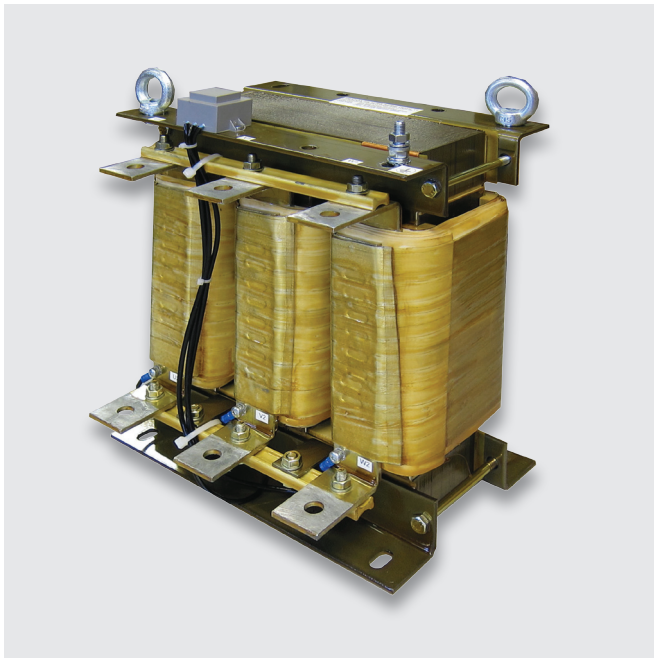

- Protects the motor-reducing dU/dt value of the drive output voltage
- Reduction of motor temperature
- Increases the lifetime of the motor
- Open frame design
- UL listed materials used
- Cable length up to 300m

Motor winding insulation experiences higher voltage stresses when used with a variable speed drive than when connected directly to the mains supply. The higher stresses depend on the motor cable length. The stresses are caused by the fast-rising voltage pulses of the drive and transmission line effects in the cable.

DU/dt filters reduce the insulation stress of the motors by lowering the dU/dt- value of the variable speed drive output voltage. The reduced stress increases the lifetime of the motor windings.

DU/dt filters can be used with cable lengths up to 100-300m, depending on the model.

DU/dt-filters are designed for a maximum switching frequency of 4,0 kHz. The filters generate less heat with lower switching frequencies, so it is possible to use lower switching frequencies.

DU/dt- filters can also be used in retrofit applications, where the motor is not designed for use with a variable speed drive.

According to IEC TS 60034-17, for motors rated at voltages up to 500Vac, the insulation system should typically have a satisfactory life time when subjected to peak voltages shown in the figure.

For more information about other dU/dt limits, please read Gambica / Rema technical report No. 1, third edition, Variable speed drives and motors, Motor insulation voltage stresses under PWM inverter operation.

## Schematic diagram

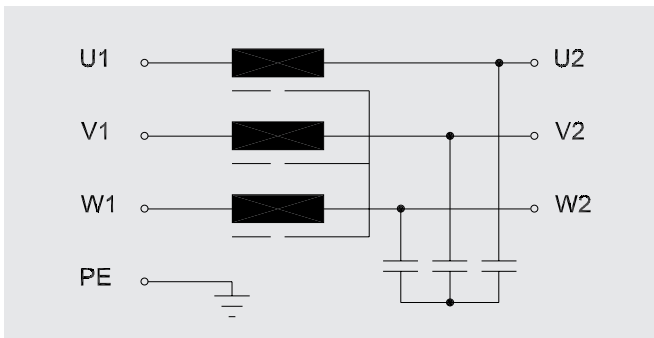

Choose a filter with a rated current greater than the rated current of the motor. If the working frequency of the motor is greater than 70 Hz, use the derating curve to determine the maximum current allowed for the filter.

Derating curve of dU/dt- filter

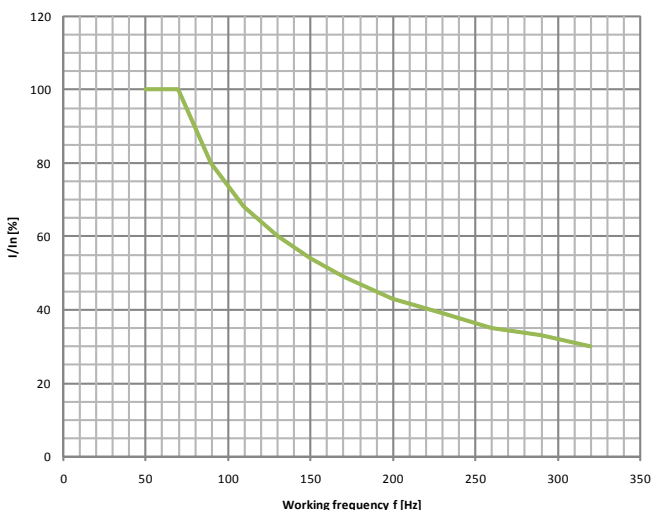

DU/dt limit curves

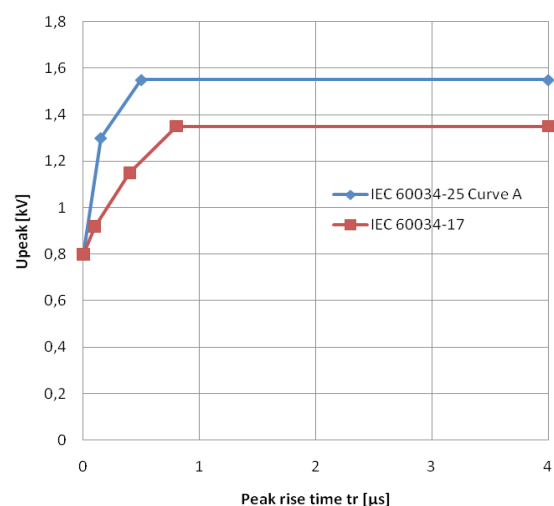

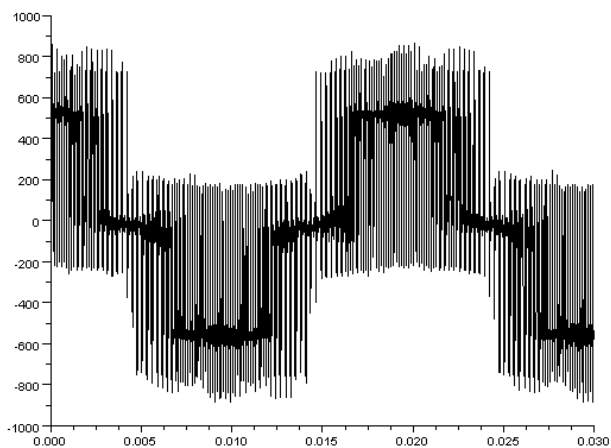

The waveform of the motor voltage without dU/dt- filter

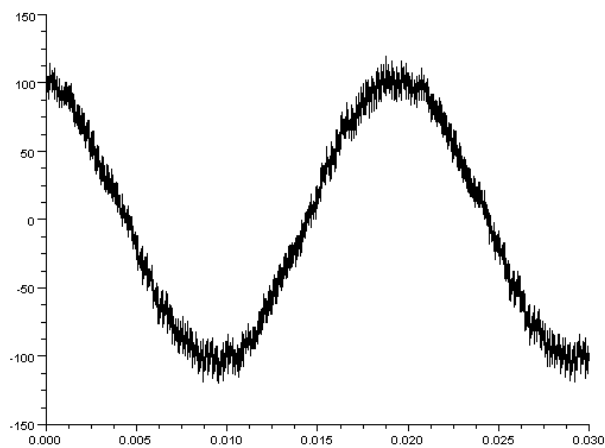

The waveform of the motor current with dU/dt- filter

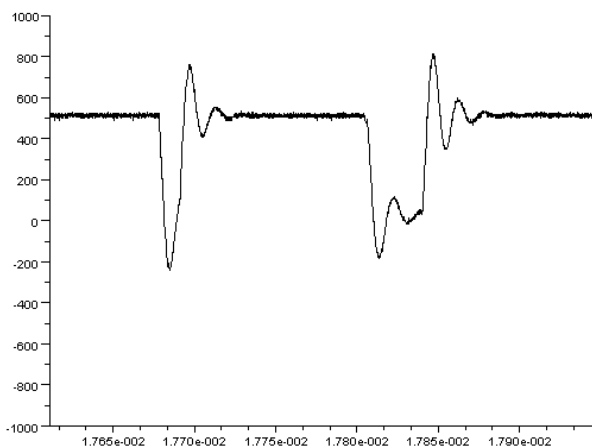

The typical voltage pulse shape in the terminals of the motor with dU/dt- filter

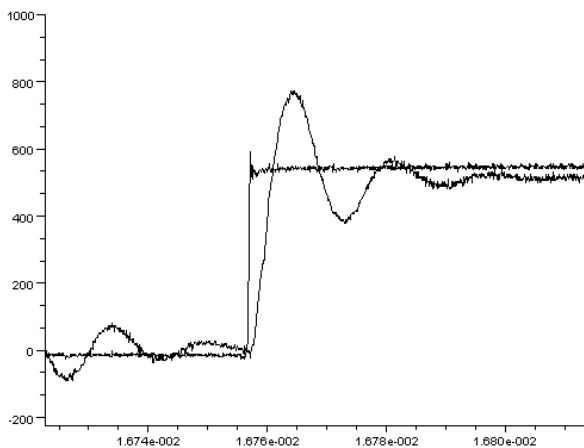

The typical voltage pulse of the inverter output and the voltage pulse of the motor input with dU/dt- filter.

## Technical specifications

<b>Standards</b>	EN 61558-2-20, LVD 2006/95/EC, UL/Ur, RoHs, CE
<b>Design</b>	Open frame design
<b>Operating voltage range</b>	3x200-690 Vac $\pm$ 10%
<b>Motor frequency</b>	0-70 Hz without derating 70-320 Hz with derating
<b>Max switching frequency</b>	4 kHz
<b>Typical overshoot</b>	50 % of DC link voltage

<b>Voltage loss</b>	< 5V at nominal current
<b>Ambient temperature</b>	- 20 ... +40 °C in operation
<b>Storage temperature</b>	- 20 ... +70 °C
<b>Humidity</b>	<95 % RH, no condensation
<b>Overload capacity</b>	1,5 rated current for 1min, once per 60min
<b>Insulation temp. class</b>	H 180 °C
<b>Protection class</b>	IP00

Rated current [A]	Inductance [uH]	Typical losses [W]	Max. cable length [m]	Cable type, max. cross section [mm <sup>2</sup> ]
12	900	50	100	3x10+10 Cu
25	355	70	100	3x10+10 Cu
55	196	110	150	3x35+16 Cu
80	135	130	150	3x35+16 Cu
130	83,1	180	200	3x95+70 Cu
210	51,4	260	250	3x150+70 Cu
280	38,6	350	250	2x 3x120+70 Cu
350	30,9	480	300	2x 3x185 Al+57 Cu
420	25,7	510	300	2x 3x240 Al+72 Cu
600	18,0	690	300	4x 3x120 Al+41 Cu
820	13,2	950	300	4x 3x185mm <sup>2</sup> Al+57 Cu
1250	8,6	1080	300	6x 3x240mm <sup>2</sup> Al+72 Cu
1500	7,2	1329	300	6x 3x240mm <sup>2</sup> Al+72 Cu
2 x 1250	4,3	2210	300	6x 3x240mm <sup>2</sup> Al+72 Cu
2 x 1500	3,6	2708	300	6x 3x240mm <sup>2</sup> Al+72 Cu
<b>Water cooled</b>				
1250	8,6	1240	300	2x 6x 3x240mm <sup>2</sup> Al+72 Cu
1500	7,2	1440	300	2x 6x 3x240mm <sup>2</sup> Al+72 Cu

Note! The maximum cable length is limited. When the cable length is over the maximum value the filter will overheat. If the cable length is not sufficient use a filter one size larger.

## Mechanical data 12A - 25A

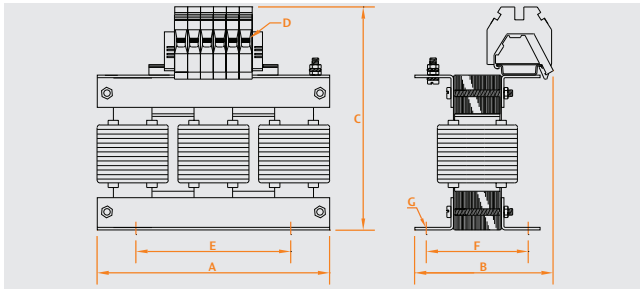

## Mechanical data 55A - 80A

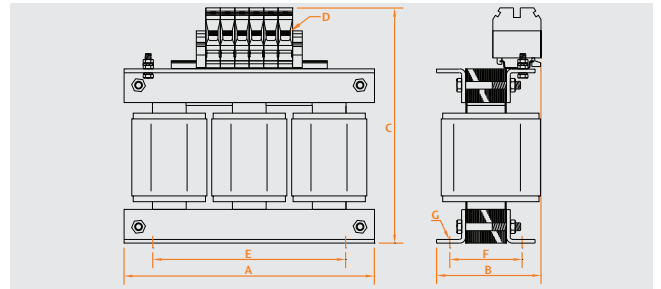

## Mechanical data 130A - 820A

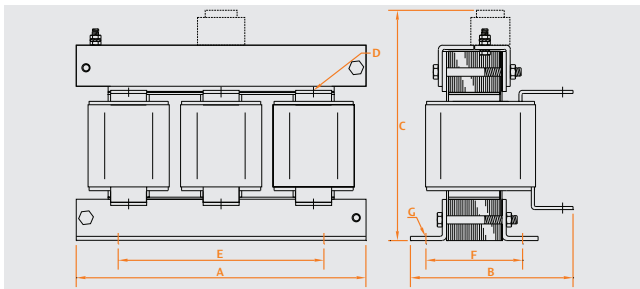

## Mechanical data 1250A - 1500A

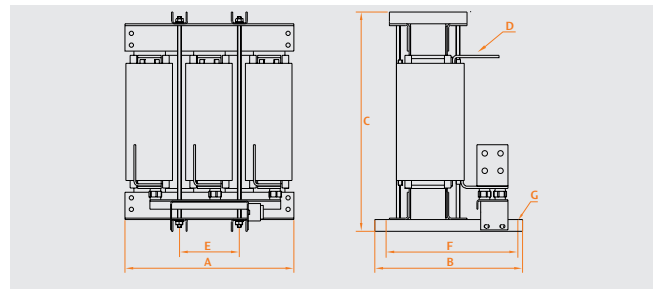

Rated current [A]	A [mm]	B [mm]	C [mm]	D [mm <sup>2</sup> ]	E [mm]	F [mm]	G [mm]	Weight [kg]	Cu / Al weight [kg]
<b>Order code</b>									
DUDT12	134	80	135	10	126	51	6x7	2,30	Cu 0,27
DUDT25	180	107	175	10	120	79	8x14	5,40	Al 0,28
DUDT55	225	100	208	35	176	77	10x13	9,20	Al 0,88
DUDT80	245	110	245	35	176	78	10x13	12,90	Al 2,19
DUDT130	245	160	190	Busbar 7x11	176	88	10x13	16,80	Al 2,19
DUDT210	282	215	240	Busbar Ø10	200	117	11x20	26,60	Al 3,13
DUDT280	282	220	310	Busbar Ø10	250	135	11x20	38,80	Al 3,29
DUDT350	300	240	385	Busbar Ø14	250	154	11x20	50,00	Al 5,60
DUDT420	310	245	395	Busbar Ø14	250	158	11x20	55,00	Al 6,29
DUDT600	360	280	395	Busbar Ø14	250	164	11x20	72,00	Al 12,29
DUDT820	375	280	510	Busbar Ø14	250	164	11x20	98,00	Al 12,81
DUDT1250	433	377	556	Busbar 4xØ14	153	337	13x18	132,00	Al 10,39
DUDT1500	442	433	670	Busbar 4xØ14	143	393	13x18	166,00	Al 17,30
DUDT2x1250	886	377	556	Busbar 4xØ14	153	377	13x18	279,00	Al 20,78
DUDT2x1500	904	433	670	Busbar 4xØ14	143	393	13x18	347,00	Al 34,60
<b>Water cooled</b>									
DUDT1250W	390	370	546	Busbar 4xØ14	108	330	13x18	85,00	Al 17,12
DUDT1500W	390	375	573	Busbar 4xØ14	108	335	13x18	105,00	Al 18,39

## Muuntosähkö

Trafox is a brand of Muuntosähkö Oy. We develop, manufacture and customise high-quality transformers, chokes, filters and Trafox Superintend® monitoring devices for a large number of applications.

MUUNTOSÄHKÖ OY TRAFIX

P.O. Box 10 | FI-00621 Helsinki | Tel. +358 207 933 700 | Fax +358 207 933 746 | sales@trafox.fi



www.trafox.fi